



Boraam Industries

ASSEMBLY INSTRUCTIONS

SKU: 77315

RASMUS DINING BENCH

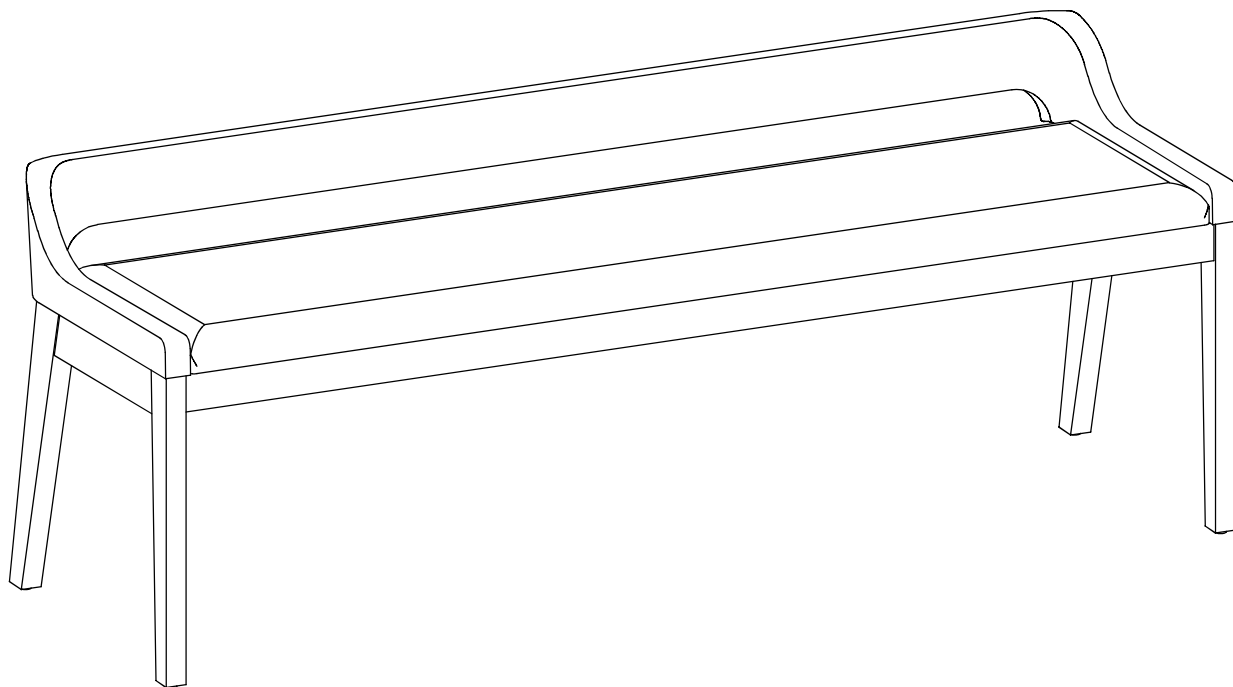

Have questions about
assembling your item?



Items or parts damaged?



Missing a part?

We're here to help! (Monday-Friday from 9am-5pm CST)



847-949-6300
877-267-2261



customerservice@
boraamindustries.com



www.boraamindustries.com



M8*10
8 PCS

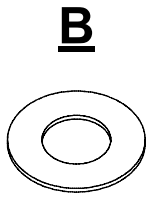

M8*16
8 PCS

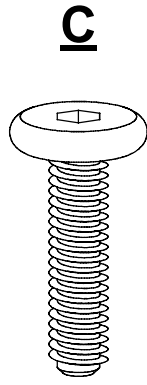

M8*45
8 PCS

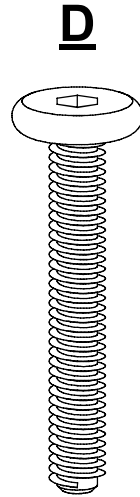

M8*50
2 PCS

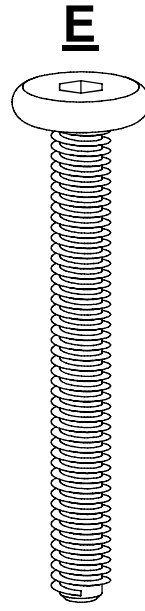

M8*70
4 PCS

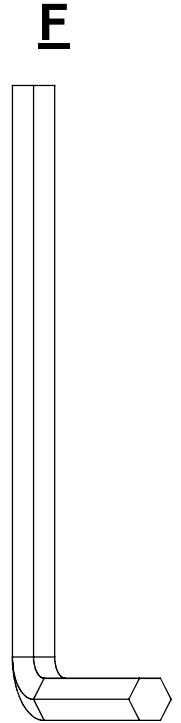

M4*110
1 PC

1

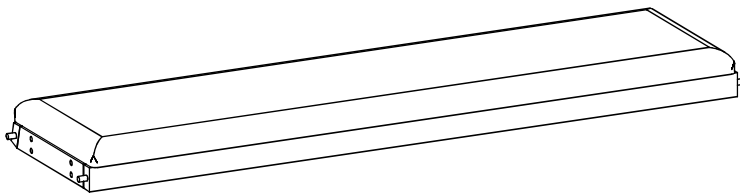

2

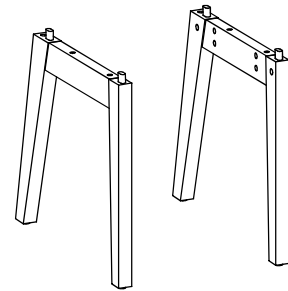

3

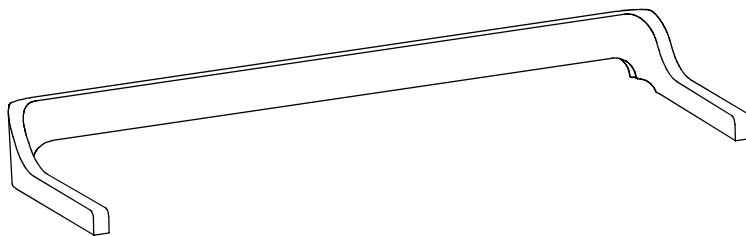

01

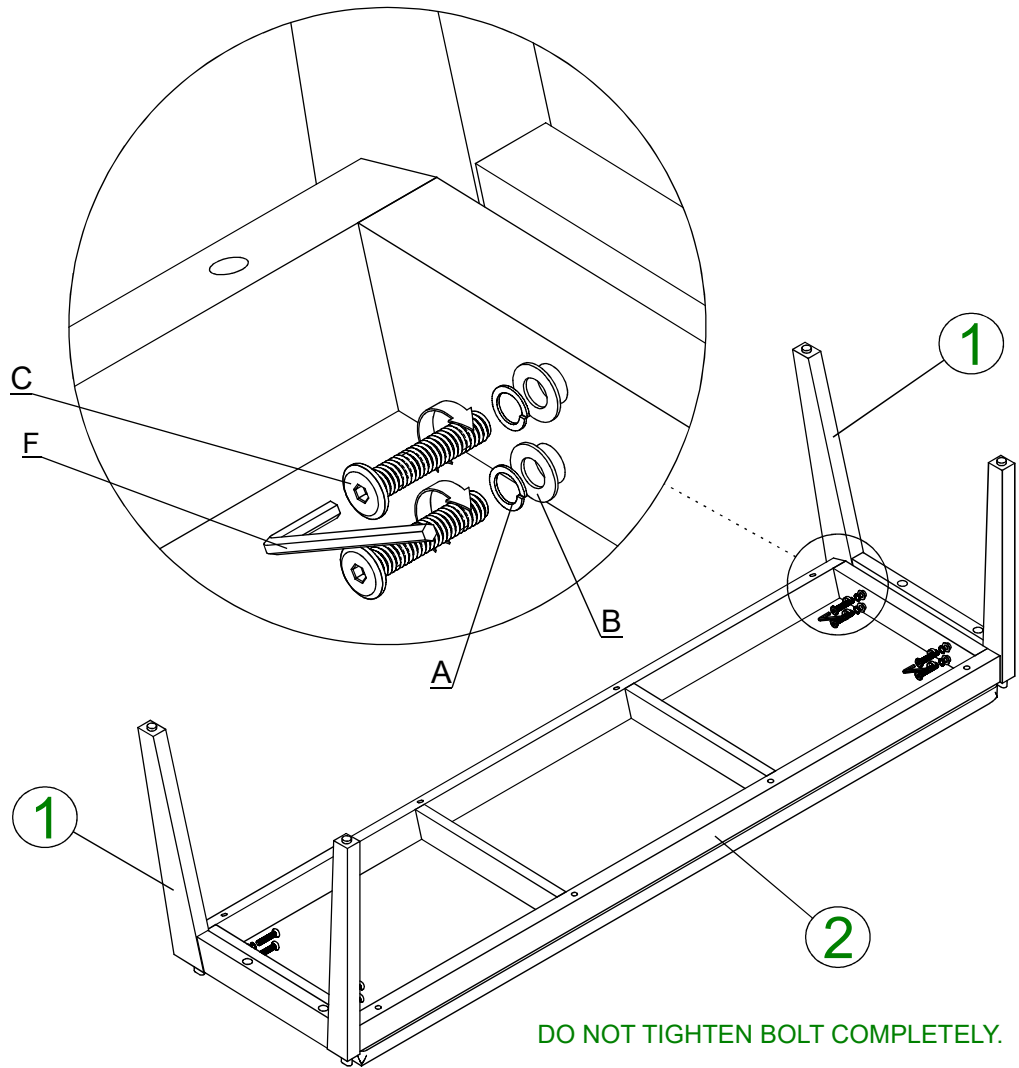
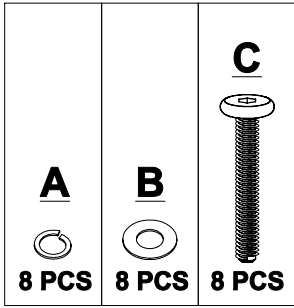

DO NOT TIGHTEN BOLT COMPLETELY.

02

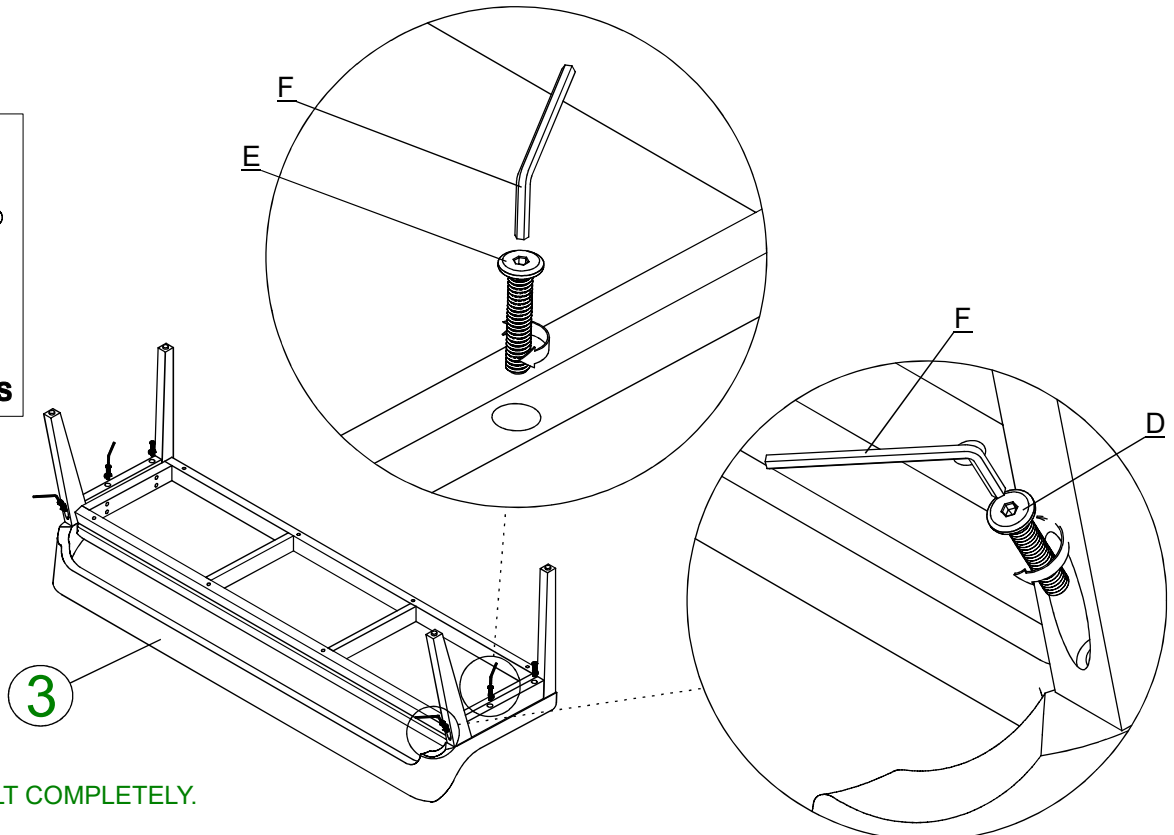
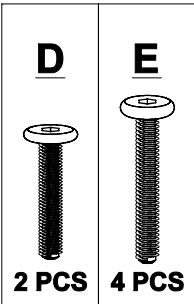

TIGHTEN BOLT COMPLETELY.

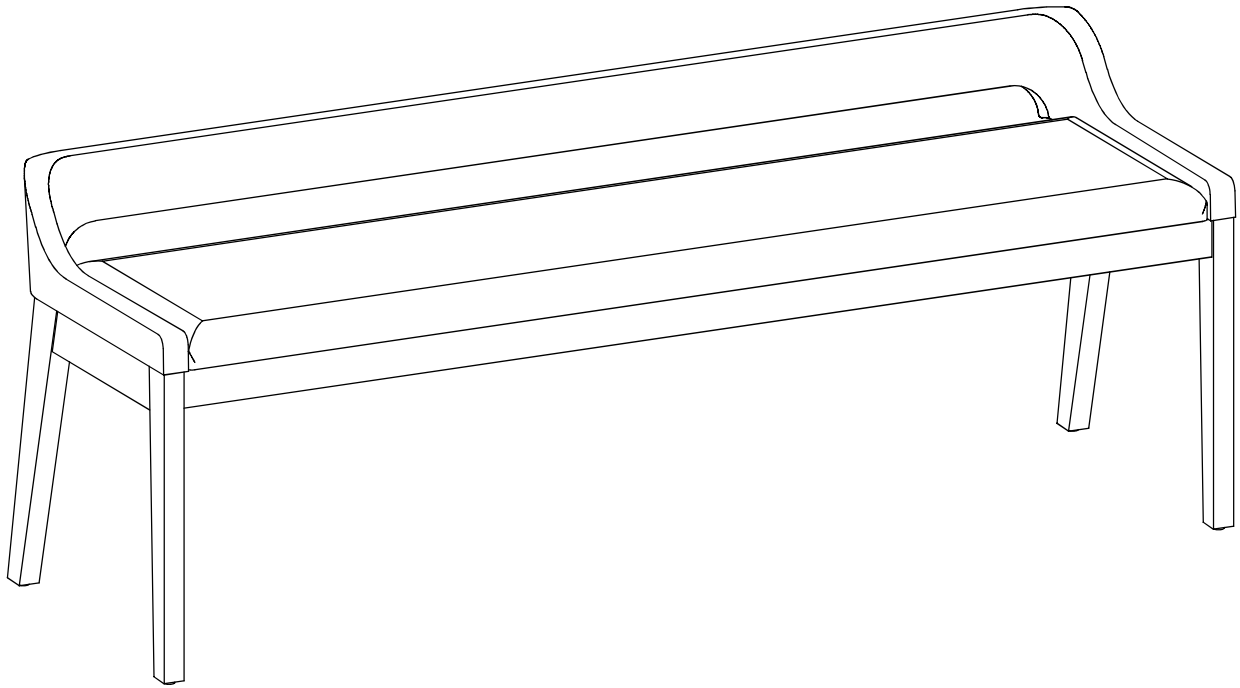

BE SURE TO CHECK ALL BOLTS ARE SECURELY
TIGHTENED PRIOR USING THIS STOOL.